

Documentation type: Operating manual
Author: J. Schumann

Last modification:

Last modification by: Dietgard Mayer-Eckardt

Print date: 2015-03-18

Comment:

Last saving date: 2015-03-18

Operating Manual for

SIFCO PROCESS® ADVANCED POWER PACK

Model SP 15-50-115-1



DC-output: 15A / 50V

Read this operating manual completely before installation.

Not following installation and operation procedures will void the warranty. It also could result in serious injury or death.



List of Contents:

1	EU Declaration of Conformity-----	5
2	General description -----	6
2.1	Intended purpose-----	7
3	Security advise -----	8
3.1	Class-A device-----	8
3.2	Security -----	8
4	Installation, electrical connections -----	9
4.1	DC-output connection -----	9
5	Readout and BUS signals at X4-terminal-----	10
5.1	Connecting list of terminal X4 -----	10
5.2	Address setting -----	11
5.3	Bus termination -----	11
5.4	BUS cable specification -----	11
6	Mains supply -----	12
6.1	PFC technology-----	12
7	Back plane-----	12
8	Overload detection -----	13
9	Operation -----	14
9.1	Main switch -----	14
9.2	LCD display-----	14
9.3	Set output voltage-----	15
9.4	Set output current-----	15
9.5	Select output polarity-----	15
9.6	AUTO pole changer mode -----	16
9.7	Manual start of preset counter, reset-----	16
9.8	Setting of the preset counter -----	16
10	Standard functions: current and voltage regulation-----	17
10.1	Constant current regulation-----	17
10.2	Constant voltage regulation -----	17
11	Using the AH Counter -----	18
12	A/H RESET key functions -----	20
12.1	Reset-----	20
12.2	Setting the AH Counter Auto-Start-----	20
13	Key pad functions-----	21
13.1	The key pads to the right hand side -----	21
13.1.1	Key „ON“ -----	21
13.1.2	Key „OFF“-----	21
13.1.3	Key „Enter“ -----	21
13.1.4	Key „CLR“-----	21
13.2	Second key pad row-----	22
13.2.1	Key „increase voltage“-----	22
13.2.2	Key „decrease voltage“-----	22
13.2.3	Key „increase current“-----	22
13.2.4	Key „decrease current“-----	22
13.3	The key pads to the left hand side -----	23
13.3.1	Key „+/-“ Manual pole changing-----	23
13.3.2	Key „AUTO“, AUTO pole changer mode-----	23
13.3.3	Key „ A/H RESET “, manual start of preset counter, and reset -----	23
13.3.4	Key „F4“, direct setting of the preset value-----	23
14	Setting in main menu -----	24
14.1	General description-----	24

14.2	The SETTINGS functions -----	24
14.2.1	Example-----	25
15	Specific description of the functions-----	26
15.1	Configuration of the preset counter-----	27
15.2	Configuration of the pole changer-----	31
15.3	Configuration of the Overload detection-----	33
15.4	Configuration of BUS-Controlling -----	34
16	Switching to AUTO mode (RS485 BUS controlling)-----	36
16.1	General description-----	36
17	Technical data-----	37
18	Preventative maintenance-----	38
18.1	Service-----	38
19	Checking calibration -----	39
20	Spare parts list -----	41
21	Warranty and Repair Information -----	41

1 EU Declaration of Conformity

Conformity declaration of the European community corresponding to the EMV-guidelines 2004/108/EG about the electromagnetic compatibility and the low-voltage guidelines 2006/95/EG.

We

Manufacturer: plating electronic GmbH
Ust.-Id Nr.: DE 141938869
Addressee: Marie-Curie-Straße 6
79211 Denzlingen / Deutschland

declare our product:

Installation: electroplating DC power supply type
SIFCO PROCESS® ADVANCED POWER PACK
SP 15-50-115-1 No.61115501
air cooled, with integrated pole changer
with preset counter, with RS485-BUS interface

Serial No.: see rating plate

on which the declaration is related to, is corresponding to the following standards resp. normative documents:

DIN EN 61000-6-2: 2005 (German Language Version)

Corrigendum to DIN EN 61000-6-2 (VDE0839-6-2): 2006;
German version CENELEC-Cor.: 2005 to EN 61000-6-2: 2005.

DIN EN 61000-6-2 Corrigendum 1: 2011; VDE0839-2 Corrigendum 1: 2011

Electromagnetic compatibility (EMC) Part 6-2: Generic standards -
Immunity for industrial environments (IEC 61000-6-2:2005)

DIN EN 61000-6-4: 2011; VDE 0839-6-4: 2011

German version: Electromagnetic compatibility (EMC) part 6-4: Generic standards -
Emission standard for industrial environments (IEC 61000-6-4: 2006 + A1: 2010)
German version EN 61000-6-4: 2007 + A1: 2011

DIN EN 55011: 2011; VDE 0875-11: 2011

(German version) Class A, Group 1

German version: Industrial, scientific and medical equipment -
Radio-frequency disturbance characteristics -
Limits and methods of measurement (IEC/CISPR 11: 2009, modified)
+ A1: 2010); German version EN 55011: 2009 + A1: 2010

DIN EN 50178: 1998 (VDE 0160: 1998)

Electronic equipment for use in power installations
German version EN 50178: 1997

RoHS-conform to guideline 2011/65/EU per June 8th 2011

Denzlingen, 30.05.2014

place / date

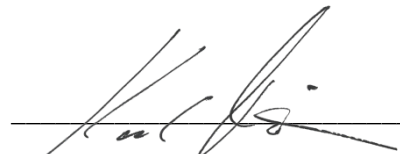

Karl Rieder (Managing director)

2 General description

The DC-power supply type **SIFCO PROCESS® ADVANCED POWER PACK SP 15-50-115-1** is a sophisticated switch mode type rectifier, designed for the electroplating industry. It is designed as a desktop unit.

The control of the output parameters is done by keys in the front panel of the unit, or by RS485 BUS (terminal X4).

The electronic regulation guarantees correct output parameters during the operation, even with variable loads at the DC output.

The pole changer can be programmed individually, according to your application.

The pole changer can be operated in MANUAL or AUTO pole changer mode.

The **preset counter** can be individually configured. The preset counter can be used to switch the DC power supply off after a certain current rate.

The **A/H RESET** key is used to start the preset counter manually (or to enable auto-start) if the plating process is running.

Over temperature protection

The device is temperature protected. If the interior temperature is exceeding the limit the device decreases the output current automatically and, after a cooling phase, increases it.



There is an auto-switch-off function in case of overheating.

Attention!

Auto-restart after cooling down!

Do not run the power supply at higher environmental temperatures than 40°C!

2.1 Intended purpose

Device for industrial application

According to the norms

DIN EN 61000-3-12 (VDE 0838-12):2012-06
EN 61000-3-12:2011

this device is only to be used for industrial applications. Offering and selling the device to the general public is not provided.

This device was designed to be used for electroplating processes in plating systems only.

All other use must be clarified with the technical support of the manufacturer. Otherwise, the installation or other connected devices could be damaged.

3 Security advise

3.1 Class-A device

This device is defined as a **class-A**-device.

Warning: This device is provided to be used only in industrial environment! In other environments, a sufficient electromagnetic tolerance could not be assured without additional installation measures.

3.2 Security



Attention!

There are components inside the casing carrying a live-endangering voltage for up to 5 minutes after turning off the power supply.

Without casing, the DC power supply has protecting grade IP00. It is dangerous to open the casing because of the possibility touching voltage-carrying parts. Therefore, it is not permitted to use the DC power supply without bottom or cover plate or with side or front / back panels removed.



- Installation, repairing and maintenance only by qualified personnel!
- Supply sufficient cooling air for the DC power supply!
- Customer and operator are responsible for the proper installation and handling of the DC power supply!
- Do not remove protection covers and do not modify the unit in any way!
- Do not use DC connectors and cables to lift or move the device!



Attention!

Do not operate any DC-power-supply with one or more loose internal cable connectors!

If during operation one or more plugs are pulled out of the boards inside the modules, electronic parts and the power unit could be destroyed!



Do not overload the relay outputs!

Maximum load of the PCB mounted relays:

48V / 500mA DC

4 Installation, electrical connections

While choosing the place of installation, please observe that the unit is completely protected from liquids and corrosive fumes.

If the unit is exposed to corrosive fume and high atmospheric humidity (>70%), provide the unit with fresh air.

4.1 DC-output connection

Connect the plating tank to the DC-output connectors of the power supply by connecting the DC-current output + and - to the tank. Check for right polarity and contact.



Look for the

DIN VDE 0298-4 / 2003-08

admitted cable cross section and the correct polarity.

The two PLUS terminals have the same potential!

The unit must be connected according to all applicable federal, state and local electrical codes. The applicable phase current can be found on the rectifier identification plate, located inside the unit.

Attention:

The connection of active loads such as batteries or DC-machines to the DC-output-connectors will cause damages to the unit!

Please check:

Make sure that the mains supply cable is directly connected to your main supply wall outlet.

Do not wire the power supply or the high-current cables into a roll or bind the supply and the high-current wiring together with other wires. Otherwise, overheating is possible.

5 Readout and BUS signals at X4-terminal

At the X4-terminal, the readout signals of current and voltage output are to be found as well as the contacts of the indication relay, the auxiliary voltages, the shunt signal and the BLOCKING input (see connecting list). Further, the RS485 BUS signals and the 5V DC for BUS-termination are to be found here.

The control cable must be connected to the X4 terminal. Use shielded control cable with wire cross section of 0.34mm^2 .

If the control cable is longer than 15m, use wire cross section 0.5mm^2 .

One end of the shield must be connected to PE.



16

1

Attention: pin1 is located to the right hand side

5.1 Connecting list of terminal X4

Attention: Pin 1 is located to the right hand side of the connector!

Pin	Signal
1	+ I-act output 0 ... 10V
2	+ U-act output 0 ... 10V
3	Ref. GND
4	not used
5	Uref. 10V
6	not used
7	-Ushunt (0 ... -60mV for 0A ... I_{nom}) output
8	+Ushunt (GND)
9	+ 5V RS485 BUS
10	A RS485 BUS
11	B RS485 BUS
12	GND RS485 BUS
13	BLOCKING (connected to COM GND = DC output OFF)
14	Indication relay NO
15	Indication relay COM
16	Indication relay NC

5.2 Address setting

The address setting is set to a standard address (see RS485 setting menu). If the device is used in a regular bus line, please enter an individual and valid address by using the RS485 setting menu.

5.3 Bus termination

If the device is used in a regular bus line, connect the bus termination resistors at the last participant within the bus line.

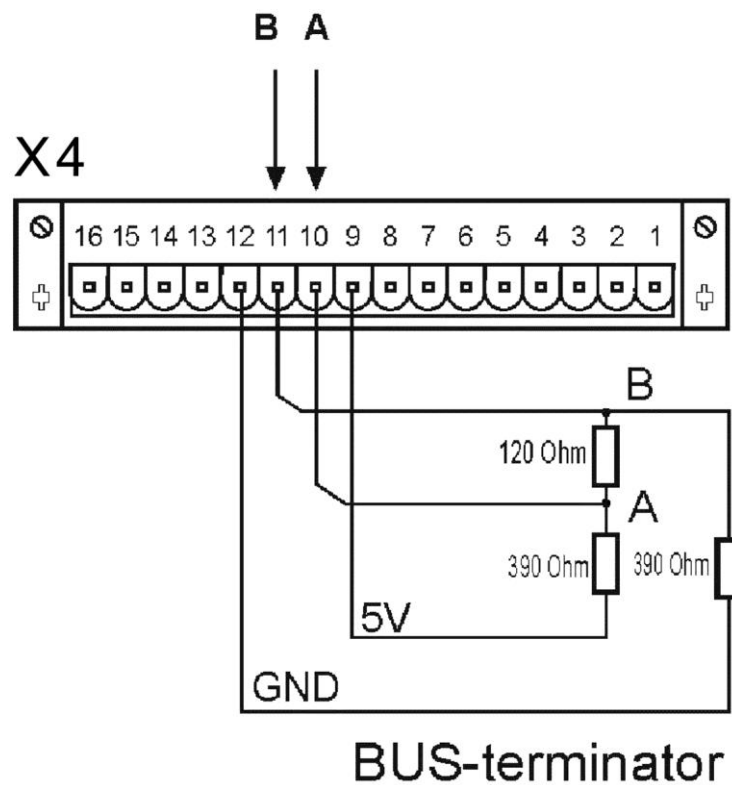

5.4 BUS cable specification

HELUKABEL
type 2 x 2 x 0.22 mm²
(AWG23)
2 pairs stranded
shielded
white, brown, green, yellow

6 Mains supply

Supply voltage: 115V AC +/-10% 50-60cps, single phase

Use the pre-wired mains cable to connect the device to the corresponding mains network.

Respect the information on the rating plate, which is located on the right side panel of the casing.

6.1 PFC technology

The PFC technology (Power Factor Control) allows a reduced phase current by increasing the efficiency of the power part.

7 Back plane



- 1 = Power supply 115V AC / 50-60cps
- 2 = X4 terminal (connecting list see above)
- 3 = Fuses 2 x 16At / 250V AC (5 x 20mm)
- 4 = Cooling air inlet

8 Overload detection

Usually, the operating mode for the expected use of this DC power supply is CV (Constant Voltage regulation).

The process this device is used for should never be affected by a short-circuit.

Overload detection rules:

- the actual output current reaches its set point
- the actual output voltage goes down to a defined voltage drop threshold within a short amount of time (50ms)

The overload function integrated in the device will react in this way:

The DC power supply will switch to BLOCKING mode immediately (DC output OFF).

The voltage drop threshold can be set from 1% to 99%.

The recommended value is 20-40%.

If an overload occurs:

The display shows:

“OVERLOAD”

and a short “beep” is heard.

The LED in OFF key is flashing (indication for BLOCKING mode).

The LED in CLR key is flashing.



Press CLR key for alarm reset.



Press the ON key to restart the DC power supply.

9 Operation

9.1 Main switch



The DC-power-supply must be switched on by using the main switch in the front panel (key ON / OFF, to the left hand side).

The LED between the two buttons lights up if the unit is switched on.

9.2 LCD display

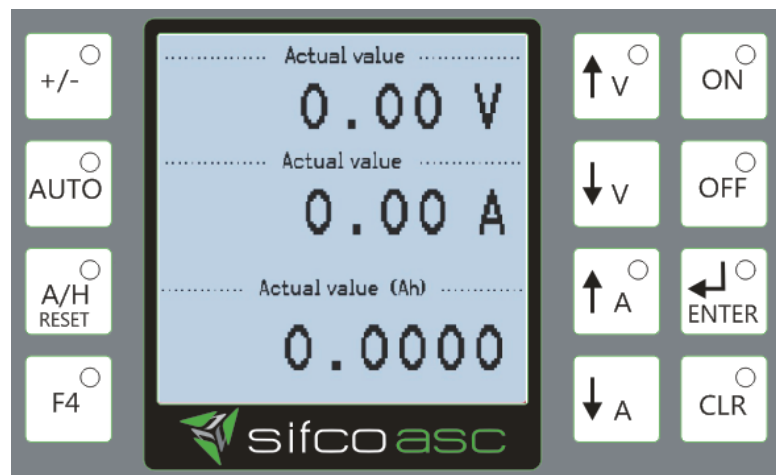

In normal operating mode, the digital display shows the actual current and voltage parameters of the DC power supply.

In the third line the Ah count is shown.

Corresponding to the selected operating mode the display can show the parameters of additional functions

The display can also show error messages.

9.3 Set output voltage

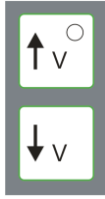

Use the “Voltage Up key” or “Voltage Down key” to adjust the output voltage.

The LED in keypad “Voltage Up”  lights up if the unit works in constant voltage mode.

“Constant voltage” is the normal mode for brush plating and is the default setting for your power pack!

9.4 Set output current



Use the “Current Up key” or “Current Down key” to adjust the output current

The LED in keypad “Current Up”  lights up if the unit works in constant current mode.

Constant current is the normal mode for brush anodizing! If you would like to set this unit to operate in constant current mode, follow the instructions below, item “**Constant current regulation**”.

9.5 Select output polarity

In the **manual** operating mode, **(which is the default setting for this unit)**



To operate in **forward polarity** the **+/-** key must be switched **off** (the red LED will be **OFF**).



To operate in **reverse polarity** the **+/-** key must be switched **on** (the red LED will be **ON**).

9.6 AUTO pole changer mode



The pole changing is done by programmed timing for cathodic and anodic position. Press "ON" key to start the AUTO pole changing *)

The LED is used to indicate the AUTO mode.



*)
You can select the start polarity for the automatic pole changing by pressing the +/- key while AUTO key is on and the LED in Off key lights up (DC output off).

9.7 Manual start of preset counter, reset



The A/H RESET key is used to start the preset counter manually (or to enable auto-start) if the plating process is running. If you want to reset the actual count of the preset counter, press the A/H RESET key. If the LED lights up the preset counter is enabled (auto start released).

9.8 Setting of the preset counter



The **F4** key is used to set the Ah count preset value directly.

10 Standard functions: current and voltage regulation

The setting of the output voltage and output current in standard operating mode is done as described in the following:

10.1 Constant current regulation



If a constant current is needed, follow these terms:

First, move the output voltage to the highest admitted level for your process by using the “Voltage Up” or “Voltage Down” key.



Now use the “Current Up key” or “Current Down key” to adjust your DC-current.

The selected output voltage and current values are shown on the digital displays.

The LED in keypad “Current Up”  lights up if the unit works in constant current mode.

After two seconds without key actuation, the actual values are indicated again.

10.2 Constant voltage regulation



If a constant voltage is needed, follow these terms:

First, move the output current to the highest admitted level for your process by using the “Current Up” or “Current Down” key.

Now use the “Voltage Up key” or “Voltage Down key” to adjust your DC-voltage.

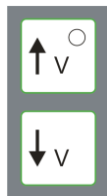

The selected output voltage and current values are shown on the digital displays.

The LED in keypad “Voltage Up”  lights up if the unit works in constant voltage mode.

After two seconds without key actuation, the actual values are indicated again.

11 Using the AH Counter

Press the OFF key.

Press the **A/H RESET** key



to reset the counter.

A short message is displayed:

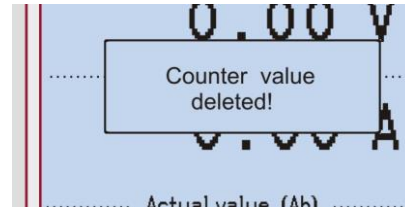

The Ah counter display shows "0.0000"

During the process the actual AH count is displayed in the bottom line.



To preset the AH counter, press the **F4** key



The left decimal is marked:



Use the keys

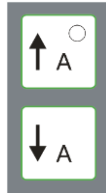

to set the desired value on the left of the decimal point.

Confirm your setting with ENTER.



The right decimals are marked:

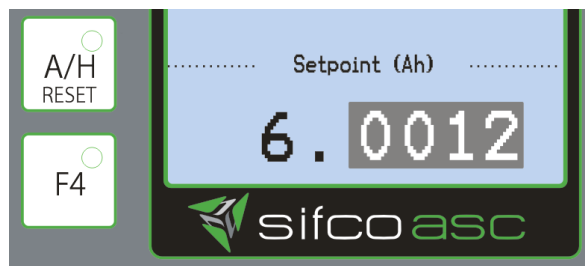

Use the keys

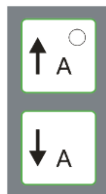

to set the desired value on the right of the decimal point.

Confirm your setting with ENTER



The preset value is stored, and the Ah counter display shows "0.0000" again.

The red LED in **A/H RESET** key is off.



If you want to **disable the preset counter** set the preset value to zero!

12 A/H RESET key functions



If the LED in **A/H RESET** key is **off** the counter is disabled, that means it is not recording ampere-hours.

If the DC power supply is running, you can start the preset counter at any time by pressing the **A/H RESET** key.

The LED in **RESET A/H** key will light up, and the count starts.



Note:

You cannot stop the preset counter by pressing the **A/H RESET** key again but you can **reset** the counter immediately, by pressing the **A/H RESET** key.

The preset counter will automatically stop if the DC power supply is in **OFF mode** (LED in OFF key lights up continuously).

The actual count will be remained.

12.1 Reset

If you want to reset the actual count of the preset counter while the process is running, press the **A/H RESET** key. The preset counter restarts automatically.

12.2 Setting the AH Counter Auto-Start



To enable the AH counter to start automatically when the output is switched to the ON position, press the **A/H RESET** key so that the LED is illuminated before turning on the output to the leads.

If the DC power supply is in OFF mode (LED in OFF key lights up continuously) press **A/H RESET** key to enable auto-start of the preset counter. The LED in **A/H RESET** key lights up.

If the DC power supply is started by pressing the ON key, the preset counter will start automatically.



Note:

In case the preset counter was not reset before turning the main power off, the actual count of the preset counter will be stored.

13 Key pad functions

13.1 The key pads to the right hand side

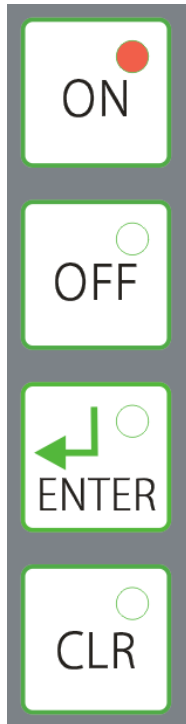

13.1.1 Key „ON“

Switch the DC power supply on by using the electronic ON / OFF function.

- ON, if LED lights up

13.1.2 Key „OFF“

Switch the DC power supply off

- OFF, if LED lights up

13.1.3 Key „Enter“

- Open setup menu

- Confirm setting

13.1.4 Key „CLR“

- Cancel procedure, back to operating mode

- Receipt error and warning messages, relay reset

13.2 Second key pad row

Up – Down keys:

In standard operating mode the Up – Down keys are used to adjust the output voltage and current infinitely.

Current and voltage settings:

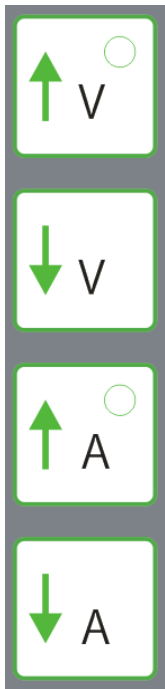

13.2.1 Key „increase voltage“

Press key to increase the output voltage

If LED lights up: constant voltage regulation mode active

13.2.2 Key „decrease voltage“

Press key to decrease the output voltage

13.2.3 Key „increase current“

Press key to increase the output current

If LED lights up: constant current regulation active

13.2.4 Key „decrease current“

Press key to decrease the output current



As soon as one of the four keys is pressed, the display switches from operating mode to setting mode for current and voltage setting.

Short pressing on the key changes the value by one digit.

Constant pressing causes continuous change of the value.

The changes can also be done if the OFF button (to the right hand side) was pressed (DC power supply switched off electronically).

After two seconds without key actuation, the actual values are shown again.

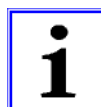

In setting menu, the arrow keys are used to select an item and to adjust the values.

13.3 The key pads to the left hand side



13.3.1 Key „+/-“ Manual pole changing

Press key to change polarity, if AUTO mode is not enabled.

If AUTO mode is ON and the ON key was pressed, you can press +/- key to show the actual position of the pole changer.

13.3.2 Key „AUTO“, AUTO pole changer mode

The pole changing is done by programmed timing for cathodic and anodic position. Press “ON” key to start the AUTO pole changing *)

The LED is used to indicate the AUTO mode.

13.3.3 Key „A/H RESET“, manual start of preset counter, and reset

The **A/H RESET** key is used to start the preset counter manually (or to enable auto-start) if the plating process is running. If you want to reset the actual count of the preset counter, press the **A/H RESET** key. If the LED lights up the preset counter is enabled (auto start released).

13.3.4 Key „F4“, direct setting of the preset value



*)
You can select the start polarity for the automatic pole changing by activating or de-activating the +/- key while “AUTO” key is on and the LED in Off key lights up (DC output off).

Key F4:



Attention:

The preset counter is not switched ON and OFF by the **F4** key. The **F4** key is only used for direct setting of the preset value!

14 Setting in main menu

14.1 General description

Open the main menu by pressing the **ENTER** key.



The display shows:

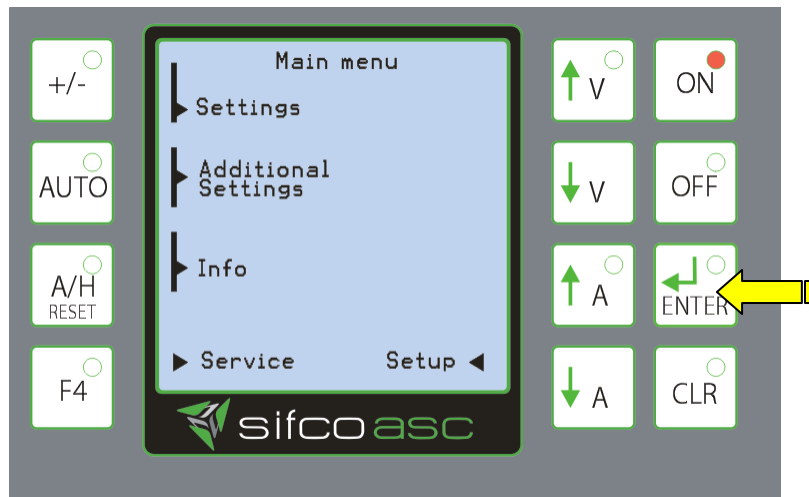

Select the desired menu point by pressing the corresponding key.

(Press CLR-key to come back to the main menu screen.)



14.2 The SETTINGS functions

If you are in the main menu as shown above, press the +/- key

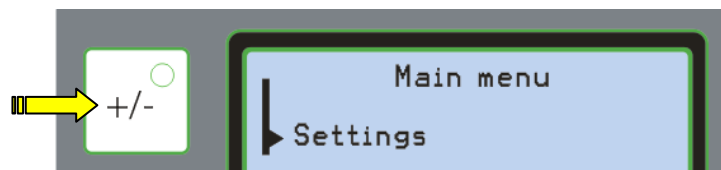

The **SETTINGS** menu is the menu for the most important process settings:

- Preset counter
- Pole changer
- Overload detection
- RS485 BUS settings / manual – auto setting

The display shows the standard function menu:

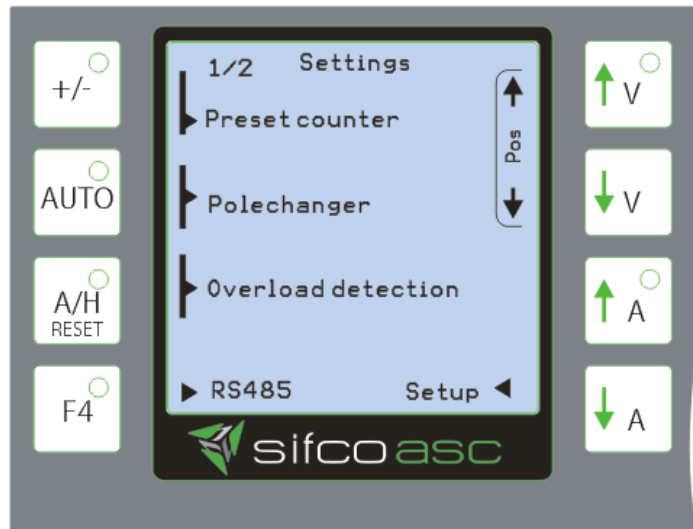

Select the desired sub item of the menu point by pressing the corresponding key.

(Press CLR-key to come back to the main menu screen).



14.2.1 Example

If you are in the in the “Settings” menu as shown above press the **AUTO** key to set the **Pole changer**:

The display shows:

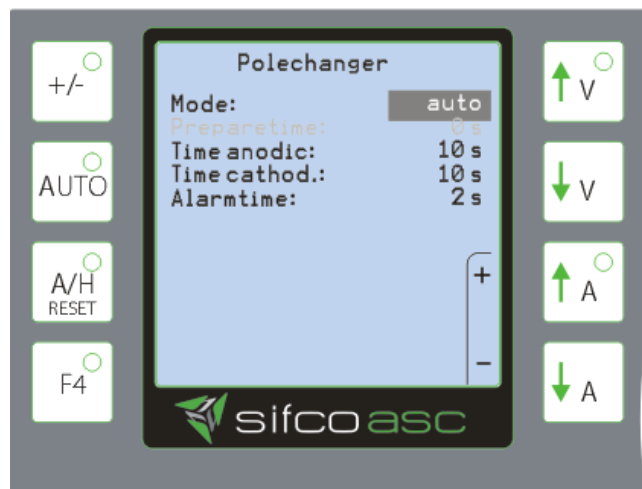

Select the desired item; in our example above:

MODE: **auto**

of the menu point “Pole changer” by using the voltage Up / Down arrow keys.



The desired item is marked (see above)

Select now the desired setting by using
the current Up / Down keys.

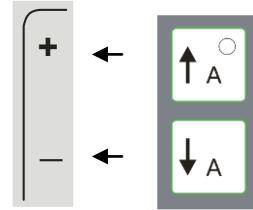

15 Specific description of the functions

In the following the functions

- Preset counter
- Pole changer
- Overload detection
- RS485 BUS settings / manual – auto setting

are described.

15.1 Configuration of the preset counter

In the preset counter menu, five items are available:

- Direction: shows the direction of counting (up / down)
- Setpoint: shows the desired preset value
- Reset now: No: current value will be kept
Yes: current value will be deleted
- Alarmtime: shows the selected alarm time
- Switch off: shows the switching functions of the connected DC power supply (inactive, Blocking, OnRelay)

The display shows:



Select the desired item of the menu point "preset counter" by using the arrow keys.

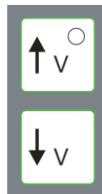

The desired function is marked (see above)

Select now the desired setting by using the Up / Down keys

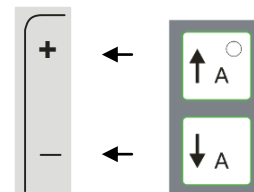

Menu point “direction”

Set the counting direction of the preset counter:

- up: counter counts from zero to preset value (incremental)
- down: counter counts from preset value downwards to zero (decremental)

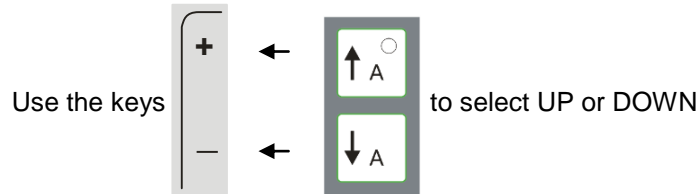

Direction:	up
Setpoint:	0.0000
Reset now:	No
Alarmtime:	5 s
Switch off:	inactive

Confirm the setting with ENTER.



The cursor will jump to the “Setpoint” line.

Menu point “setpoint”

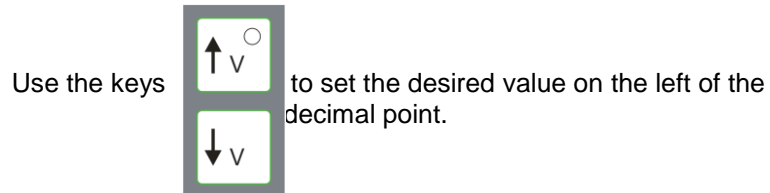

Setpoint:	6.0000
-----------	--------

Confirm the setting with ENTER.

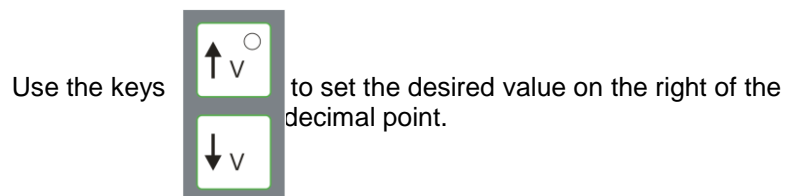

Setpoint:	6.0000
-----------	--------

Confirm the setting with ENTER.



Menu point “Reset now”

In this menu point, you can reset the actual count of the preset counter.

Select “NO” to keep the actual count.

Select “YES” to set the value to zero.

Please note that the same function is also available via key **A/H RESET**.

Use the keys  to select YES or NO

Confirm the setting with ENTER.



Menu point “Alarm time”

In this menu point the alarm duration of the acoustic alarm - which is started if the preset counter has reached the final value - can be set.

Possible settings: 0 (alarm disabled) to 999 seconds.

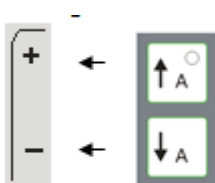
Use the keys  to set the value

Short pressing on the key changes the value by one digit.

Constant pressing causes continuous change of the value.

Confirm the setting with ENTER.



Menu point “Switchoff”:





The switching functions for the DC power supply after the preset counter has reached the final value can be configured here.

The Following settings are available:

inactive = switching off disabled

Blocking = switching the DC output of the DC power supply off by BLOCKING function

OnRelay = switching the DC power supply off by using the Extern-ON function

Use the keys  or  to select “inactive” (*), “BLOCKING” or “OnRelay”  

Direction: up
Setpoint: 0.0000
Reset now: No
Alarmtime: 5 s
Switch off: inactive

(*) = manufacturer setting

Confirm the setting with ENTER.



15.2 Configuration of the pole changer

In the pole changer menu four items are available:

- Mode: auto or manually
- Time anodic: shows the selected time (seconds)
- Time cathodic: shows the selected time (seconds)
- Alarmtime: shows the selected alarm time

Select the desired item of the menu point “pole changer” by using the arrow keys.

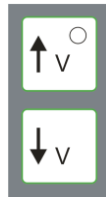

Select now the desired setting by using the Up / Down keys.

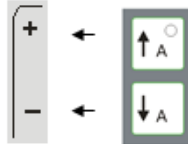

The Menu point “Mode”

Possible settings: **manually** or **auto**

manually: The +/- key  is used to set the output polarity.

auto: The pole changing is done according to the time settings in this menu point.

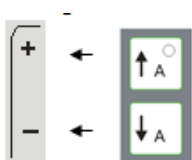
Use the keys  to select “**manually**” or “**auto**”

Confirm the setting with ENTER.



Time settings

Time anodic: for this time the polarity of the DC output is not changed

Time cathodic: for this time the polarity of the DC output is changed

Alarm time:

If the polarity has changed to "cathodic" an acoustic alarm is given out. With this menu point you can set the duration of this alarm. To disable the acoustic pole changer indication set the value to zero.

Possible settings 0 ... 10 seconds

For the three time settings:

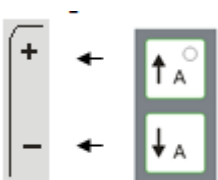
Use the keys  to set the value

Short pressing on the key changes the value by one digit.

Constant pressing causes continuous change of the value.

Confirm the setting with ENTER.



15.3 Configuration of the Overload detection

Settings:

The voltage drop threshold can be set from 1% to 99%.



The recommended value is 20-40%.

Confirm the setting with ENTER.



Function:

If a direct short occurs between the anode and the part:

The display shows:

“OVERLOAD”

and a short “beep” is heard.

The DC output is shut off.

The LED in OFF key is flashing.

The LED in CLR key is flashing.



Press CLR key for alarm reset.



Press the ON key to restart the DC power supply.

15.4 Configuration of BUS-Controlling

The following menu points are available in this menu:

- Mode: manual / Auto
- Baudrate: data transfer speed in auto mode
- Address: RS485 BUS address of this device within the BUS line
- Spec/Type: Protocol type for RS485 BUS

Select the setting menu point "RS485"

The display shows:

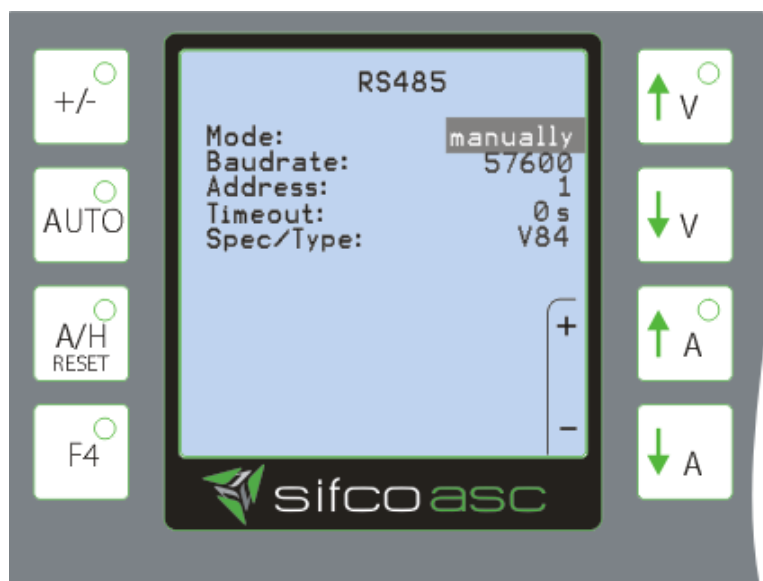

Select "manually" or "auto" mode by using the Up / Down keys.

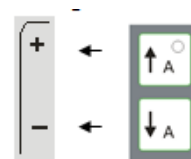

Confirm the setting with ENTER.



Menu point "Baudrate"

The data transfer rate can be set to several fix values:

300
600
1200
2400
4800
9600
14400
19200
28800
38400
57600 manufacturer setting
115200

It is recommended to start with a low data transfer rate. If the system is running error free, you can increase the data transfer speed.

Select the value by using
the Up / Down keys.

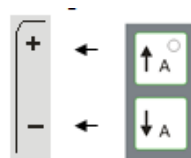

Confirm the setting with ENTER.



16 Switching to AUTO mode (RS485 BUS controlling)

16.1 General description

Two operating modes are available:

- MANUAL mode
- AUTO mode

In MANUAL mode, the unit is in operation with the key pad in the front of the unit (current and voltage setting by UP / DOWN keys).

AUTO mode:

In AUTO mode, the unit is in operation with an external remote control unit type pe280-D.

The connection to an external control unit type pe280-D is done via the **X3** connector on the back plane of the unit.

The UP / DOWN keys in the front panel are disabled in this operating mode.

17 Technical data

Device type:	SIFCO PROCESS® ADVANCED POWER PACK SP 15-50-115-1 No: 61130501
Function:	Plating DC power supply
Mains voltage:	115V AC 50-60cps
Neutral:	yes
Phase current:	13.5A / phase (PFC technology)
Advised cable cross section for mains cable:	according to DIN VDE 0298-4 / 2003-08
DC-output voltage:	0 ... 50V, infinitely variable
DC-output current:	0 ... 15A, infinitely variable
Display resolution:	10mV / 10mA
Advised cable cross section for DC cable:	according to DIN VDE 0298-4 / 2003-08
Ripple:	< 1% of nominal voltage at 300cps *)
Regulation inaccuracy:	< 1% *)
Cyclic duration factor:	100 %
Maximum load of relay output:	Max. 48V / 500mA
Environmental temperature:	0 to +40°C
Noise suppression:	according to EN 55011 curve A
Internal fuse:	16At / 500V AC (6.3 x 32mm)
Protection grade:	IP20
Cooling:	Air, by fan
Cooling air consumption:	180m ³ /h
Weight:	app. 20kg
Dimensions:	375 x 295 x 385 (W x H x D)
Casing (color):	stainless steel

*) valid for 2 – 100% of the nominal values

Other features:

- * automatic turn off at under- and over voltage with defined start level
- * protection against short circuit and open circuit
- * over temperature protected
- * power factor > 80 % (switch mode technology)

18 Preventative maintenance

The DC-power-supplies are, except the fans, service free. If you do the following maintenance procedures once a year, it would be advantageous.

- Clean the fans and blow away dirt with compressed air
(Use only oil- and water free compressed air!)
- Check the fans (function and unusual noises)
- Check the electrical connections (tightness)
- Clean the output rails

Pay attention:

It is not allowed to do any kind of constructive changes on the DC power supply!

Be careful:

There are components inside carrying a high voltage for up to 5 minutes after turning off.

Without casing, the DC-power-supply has protecting grade IP00. It is dangerous to open the casing because of the possibility to touch voltage-carrying parts. Therefore, it is not permitted to use the DC-power-supply without protection against touching.

Attention!

Do not operate any DC-power-supply with one or more loose cable connectors!

If during operation one or more plugs are pulled out of the boards inside the modules, electronic parts and the power unit could be destroyed!

18.1 Service

The DC-power-supply was built under high quality demands and has passed many function tests during production. If there is any kind of fault, please contact plating electronic GmbH.

19 Checking calibration

You can easily determine if the unit is in calibration by following the three steps below.

If all of the readings are with the special ranges, your unit is in calibration. If any one of the readings is not within the special range, your unit needs to be calibrated and should be sent to our service department for calibration.

1. Reference voltage

The reference voltage is wired up to pin 5 of terminal X4. The reference voltage is related to Ref. GND on pin 3.

Measure this voltage during operation (ON key must be pressed) by using a calibrated digital meter with resolution 1mV.

The voltage must be **10.2V DC** (+/-1%)

If this voltage is missing, an internal problem is present.

You should check the LEDs on the regulation board. Please contact our service team for further information.

2. Check the readout values

The readout values are the reference values for voltage and current DC output.

For DC current output:

The I-act. output is **0 ... 10V** (+/-1%) for 0A ... I_{nom} .

This signal is wired up to pin 1 of terminal X4. The I-act. signal is related to Ref. GND on pin 3.

Measure this voltage during operation by using a calibrated digital meter with resolution 1mV.

Example:

The nominal output current is 15A.

- press the OFF key
- short the DC output
- set the output voltage to max.
- set the output current to nominal value (15.0A)
- press the ON key
- measure the I-act signal: it must be 10.0V

For DC voltage output:

The U-act. output is **0 ... 10V** (+/-1%) for 0V ... U_{nom} .

This signal is wired up to pin 2 of terminal X4. The U-act. signal is related to Ref. GND on pin 3.

Measure this voltage during operation by using a calibrated digital meter with resolution 1mV.

Example:

The nominal output voltage is 50V.

- press the OFF key
- open (unload) the DC output
- set the output current to max.
- set the output voltage to nominal value (50.0V)
- press the ON key
- measure the U-act signal: it must be 10.0V

3. Check the indication relay

Use a buzzer or Ohm meter to check the contacts of the indication relay (pin 14 – 16 of the X4 terminal).

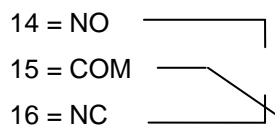

Switch the unit off by using the main switch:

The contacts 15 and 16 on terminal X4 must be closed.

Switch the unit on by using the main switch:

The contacts 14 and 15 on terminal X4 must be closed.

If not, an internal problem is present. Please contact our service team.

Other tests can only be performed if the casing is opened. Please ask for our separate trouble-shooting manual for this device.

20 Spare parts list

On request

21 Warranty and Repair Information

This unit has a two-year manufacturer's warranty, subject to the terms and conditions of the manufacturer.

Warranty/Service Locations: North America, Canada, South America

Hendor PE, Inc.
55 Concourse Way
Greer, SC 29650
Phone (864) 879-0888
Fax (864)879-4237
Email Werner@hendor-pe.com

Europe

Plating Electronic GmbH
Marie Curie Str. 6
D-79211 Denzlingen, Germany
Phone +49 (0) 7666 / 9009-0
Fax +49 (0) 7666 / 9009-44
Email martha.drayer@plating.de

Asia

Solidheat Industries, PTE Ltd.
Block 9005, Tampines Street 9
#02-266 Industrial Park A
528839 Singapore
Phone 65-6784-7591
Fax 65-6784-7590
Email kelvinsoh@solidheat.com.sg